

Date \_\_\_\_\_  
 AVFI Sales REP \_\_\_\_\_  
 Customer Signature \_\_\_\_\_

Quote No. \_\_\_\_\_  
 Customer No. \_\_\_\_\_  
 AVFI No. \_\_\_\_\_

Office Use Only

To generate your order form, please refer to the information provided below to insert the alphabetic and/or numeric code in the respective category boxes. Please note that without this filled out Order Form, your purchase **cannot** be processed.

1	2	3	4
Product Model	Finish	Chargeable Accessories	Custom Cutouts
Choose Unit (Letter) <b>MOD#- _____</b>			

### 1 Product Model



**MOD2969-S**  
Seat Height





**MOD3769-V**  
Counter Height

### 2 Choose Product Finish

Standard Finishes (Ships within 1-15 business days)

  
SST

  
SBT

  
FMT

  
AST

  
HCT

  
CLT

  
AMT

  
CPT

  
EBT

  
SGT

  
CWT

### 3 Chargeable Add-ons (Check all that apply)

Code <b>0</b> No Accessories	
Code <b>X1</b> MOD29-A Series 10U Rack 20" Depth - A Top	Qty:
Code <b>X2</b> MOD29-A EXT Series 10U Rack 23" Depth - A Top	Qty:
Code <b>X3</b> MOD29-B Series 10U Rack 20" Depth - B Top	Qty:
Code <b>X4</b> MOD29-B EXT Series 10U Rack 23" Depth - B Top	Qty:
Code <b>X5</b> MOD37-J Series 14U Rack 20" Depth - A Top	Qty:
Code <b>X6</b> MOD37-J EXT Series 14U Rack 23" Depth - A Top	Qty:
Code <b>X7</b> MOD37-K Series 14U Rack 20" Depth - B Top	Qty:
Code <b>X8</b> MOD37-K EXT Series 14U Rack 23" Depth - B Top	Qty:
Code <b>T8</b> MODU-P3 Modesty Panel	Qty:
Code	Qty:
Code	Qty:
Code	Qty:
Code	Qty:
Code	Qty:

### 3 Chargeable Accessories (Check all that apply)

* Code <b>EF</b> CHGQIB Wireless Charging Station Black	Qty:
Code <b>K1</b> C900S Single Monitor Arm	Qty:
Code <b>K2</b> C900D Dual Monitor Arm	Qty:
* Code <b>P2</b> PCH730 PC Holder	Qty:
* Code <b>K3</b> PLM1022 LCD Monitor Mount	Qty:
* Code <b>D3</b> FM3 Countdown Timer and Clock	Qty:
* Code <b>D2</b> LIGHT-18 Adjustable Gooseneck Light	Qty:
* Code <b>E3</b> CUB3 Round Cable Well	Qty:
* Code <b>E5</b> CUB5 Black Round Cable Well	Qty:
* Code <b>E6</b> CUB5 Silver Round Cable Well	Qty:
* Code <b>E8</b> CUB8 Table Top Cable Well	Qty:
* Code <b>EA</b> CUB4S Silver Power Panel	Qty:
* Code <b>EB</b> CUB4B Round Cable Well	Qty:
* Code <b>EJ</b> CUB22 Black 3 Module Panel	Qty:
* Code <b>EK</b> CUBM3 3 Module Power & Data Panel	Qty:
* Code <b>EL</b> CUBM4 4 Module Power & Data Panel	Qty:
* Code <b>D1</b> MIC-18 Gooseneck Microphone	Qty:
Code <b>M10</b> FWM100 VESA Mounting Bracket	Qty:
Code <b>P10</b> 50CAS Easy Maneuvering Casters	Qty:
Code <b>EB</b> PB12 12-Outlet 125V Powerbar	Qty:
Code <b>E1</b> PB 6 Outlet Power Bar	Qty:
Code	Qty:
Code	Qty:
* <b>Cutout Required (Extra Charges will apply)</b>	
§ Only on Flat Cutout	

All add-on options will be provided with the same finish specified in this order form. If alternative finish or accessories are required specifically for the add-on unit, please contact our sales team or visit our website for more information.

Date \_\_\_\_\_  
 AVFI Sales REP \_\_\_\_\_  
 Customer Signature \_\_\_\_\_

Quote No. \_\_\_\_\_  
 Customer No. \_\_\_\_\_  
 AVFI No. \_\_\_\_\_

OFFICE USE ONLY

Office Use Only

Comments (Please use this section to provide additional information)

---

---

---

---

---

---

---

---

---

---

Notes

**CAD Drawings/Symbols**

CAD drawings are available by request at sales@avfi.com

**Custom Cutouts**

Estimated lead time within 20 business days from receipt of P.O. and signed drawings.

**Customizations**

Modifications to design such as shape and/or size variations have to be quoted on a per case basis and are applicable for quantities of 10+ only.

Please indicate custom cutout location on the drawing(s) below

4 Custom Cutout Option (Extra charges will apply)

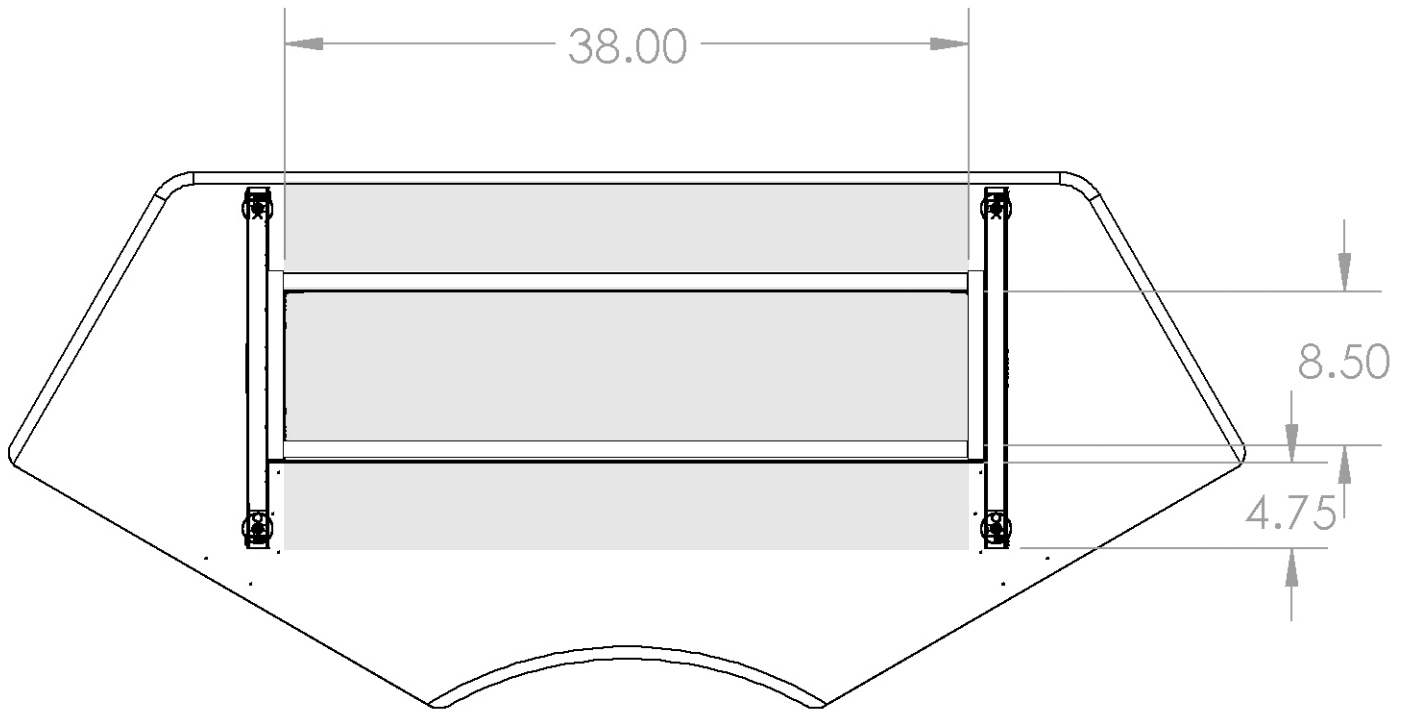

Code **CO** No Custom Cutout

Code **CC** Custom Cutout (Specify on Cutout Area Above)

■ Cutout Area - Work Surface