

Date _____
 AVFI Sales REP _____
 Customer Signature _____

Quote No. _____
 Customer No. _____
 AVFI No. _____

Office Use Only

To generate your order form, please refer to the information provided below to insert the alphabetic and/or numeric code in the respective category boxes. Please note that without this filled out Order Form, your purchase **cannot** be processed.

1 Product Model	2 Finish	3 Chargeable Accessories						4 Custom Cutouts
Choose Unit (Letter) MOD#- ____								

1 Product Model



MOD2928-A
Seat Height





MOD3728-J
Counter Height

2 Choose Product Finish

Standard Finishes (Ships within 1-15 business days)



SST



SBT



FMT



AST



HCT



CLT

AMT

CPT

EBT

SGT

CWT

3 Chargeable Accessories (Check all that apply)

Code 0 No Accessories	Qty:
* Code EF CHGQIB Wireless Charging Station Black	Qty:
Code K1 C900S Single Monitor Arm	Qty:
Code K2 C900D Dual Monitor Arm	Qty:
* Code P2 PCH730 PC Holder (Mini tower only)	Qty:
* Code K3 PLM1022 LCD Monitor Mount	Qty:
* Code D3 FM3 Countdown Timer and Clock	Qty:
* Code D2 LIGHT-18 Adjustable Gooseneck Light	Qty:
* Code E3 CUB3 Round Cable Well	Qty:
* Code E5 CUB5 Black Round Cable Well	Qty:
* Code E6 CUB5 Silver Round Cable Well	Qty:
* Code E8 CUB8 Table Top Cable Well	Qty:
* Code EA CUB4S Silver Power Panel	Qty:
* Code EB CUB4B Round Cable Well	Qty:
* Code EJ CUB22 Black 3 Module Panel	Qty:
* Code EK CUBM3 3 Module Power & Data Panel	Qty:
* Code EL CUBM4 4 Module Power & Data Panel	Qty:
* Code D1 MIC-18 Gooseneck Microphone	Qty:
Code M10 FWM100 VESA Mounting Bracket	Qty:
Code P10 50CAS Easy Maneuvering Casters	Qty:
Code E1 PB 6 Outlet Power Bar	Qty:
Code B1 9031-1 1U Utility Metal Shelf	Qty:
Code B2 9031-2 2U Utility Metal Shelf	Qty:
Code B3 9031-3 3U Utility Metal Shelf	Qty:

3 Chargeable Accessories (Check all that apply)

Code B4 9041 Sliding Metal Shelf	Qty:
Code B5 9052-2 2U Sliding Metal Drawer	Qty:
Code B6 9052-3 3U Sliding Metal Drawer	Qty:
Code J1 9107 Lacing Bar	Qty:
Code D4 FAN Quiet Cooling Fan	Qty:
Code X9 MODU-EXT Door extenders for 23" rack depth	Qty:
Code T0 MOD-LS Series Lower Shelf	Qty:
Code _____	Qty:
Code _____	Qty:
Code _____	Qty:
Code _____	Qty:
Code _____	Qty:
Code _____	Qty:
Code _____	Qty:
Code _____	Qty:
Code _____	Qty:
Code _____	Qty:
Code _____	Qty:
Code _____	Qty:
Code _____	Qty:
Code _____	Qty:
Code _____	Qty:
Code _____	Qty:
Code _____	Qty:
Code _____	Qty:
Code _____	Qty:
Code _____	Qty:
Code _____	Qty:
Code _____	Qty:

* **Cutout Required** (Extra Charges will apply)
 § Only on Flat Cutout

Date _____
AVFI Sales REP _____
Customer Signature _____

Quote No. _____
Customer No. _____
AVFI No. _____

OFFICE USE ONLY

Office Use Only

Comments (Please use this section to provide additional information)

Notes

CAD Drawings/Symbols

CAD drawings are available by request at sales@avfi.com

Custom Cutouts

Estimated lead time within 20 business days from receipt of P.O. and signed drawings.

Customizations

Modifications to design such as shape and/or size variations have to be quoted on a per case basis and are applicable for quantities of 10+ only.

Please indicate custom cutout location on the drawing(s) below

4 Custom Cutout Option (Extra charges will apply)

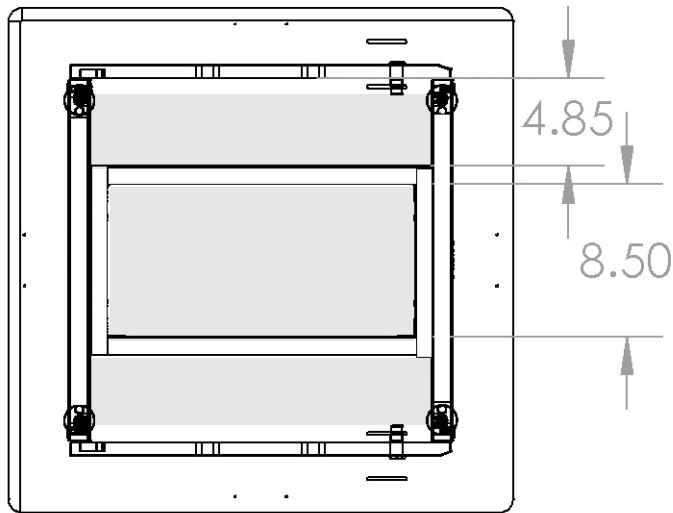

Code **CO** No Custom Cutout

Code **CC** Custom Cutout (Specify on Cutout Area Above)

■ Cutout Area - Work Surface